

# Hybrid Inverter

SUNT-6.0kW-HP

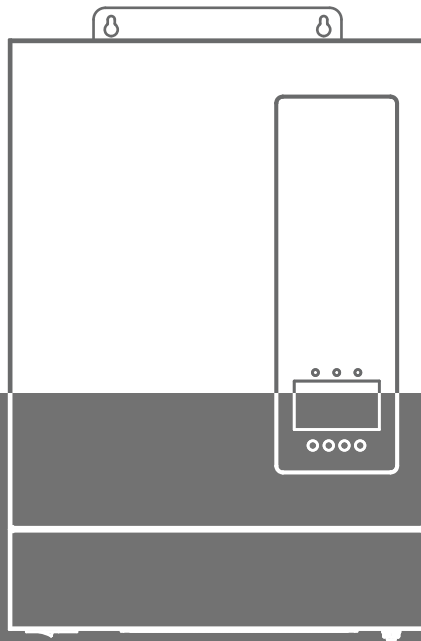









## User Manual

6.0kW HYBRID INVERTER

# Table of Contents

<b>1. About This Manual</b> .....	<b>1</b>
<b>2. Safety Instructions</b> .....	<b>2</b>
2.1 PV Safety Guidelines.....	2
2.2 Inverter Safety Guidelines.....	2
2.3 Battery Safety Guidelines.....	3
<b>3. Parts List</b> .....	<b>3</b>
<b>4. Product Overview</b> .....	<b>4</b>
<b>5. Installation Location Guidelines</b> .....	<b>8</b>
<b>6. Mounting Instructions</b> .....	<b>12</b>
<b>7. Connection</b> .....	<b>13</b>
7.1 PV Connection.....	13
7.2 Battery Connection.....	15
7.3 AC Input and AC Output Connection.....	18
7.4 Wire Current Transformer (CT) Connection.....	20
7.5 Parallel Connection.....	22
7.6 Ground Point Connection.....	33
7.7 Steps to Turn On/Off the Inverter.....	34
<b>8. System Overview</b> .....	<b>35</b>
<b>9. LCD Screen Overview</b> .....	<b>37</b>
9.1 LED Overview.....	37
9.2 Main Interface Overview.....	37
<b>10. Work Mode Overview</b> .....	<b>44</b>
10.1 Essential Load & Home Load.....	44
10.2 Work Mode Overview.....	45
<b>11. Work Mode Settings</b> .....	<b>49</b>
11.1 Battery Settings Overview.....	49
11.2 UPS Mode.....	52
11.3 Zero Export Mode.....	55
<b>12. Troubleshooting</b> .....	<b>57</b>
<b>13. Technical Parameters</b> .....	<b>59</b>

	Please ensure to review the enclosed documentation thoroughly.
	CE Mark: This inverter adheres to the requirements set forth by the relevant CE guidelines.
	Do not operate this inverter until it has been completely isolated from the battery, mains and any on-site photovoltaic generation sources.
	Additional Ground Point.
	It is imperative that the inverter is not disposed of alongside household waste.
	Caution: The surface of the inverter may become hot during operation; therefore, do not touch a running inverter.
	Warning: There exists a risk of electric shock; high voltage is present once the inverter is powered on.
	Notice: Potential hazards may arise after the inverter is activated.
	Warning: High voltage may be present; do not touch live components for a minimum of five minutes after disconnection from the power sources.

# 1. About This Manual

This guide is an important resource for the **SUNT-6.0kW-HP** inverter. It provides key information on how to install, set up, control, maintain and fix the inverter.

Before using the inverter, it's essential to read this guide carefully to ensure you understand how to operate it safely and effectively.

This manual is intended for the following inverter models:

## **SUNT-6.0kW-HP**

- **SUNT:** Product Series.
- **6.0kW:** Nominal output capacity of 6.0kW.
- **HP:** A repertoire of hybrid inverters that is economically friendly.

Installation, maintenance and grid interfacing for this inverter should only be performed by qualified personnel who meet these criteria:

- Hold relevant certifications and comply with local and national regulations.
- Have a comprehensive understanding of this manual, as well as expertise in photovoltaic systems, battery technology and electrical engineering principles.

Change History

Version 1.1 (2025-10-17)

## 2. Safety Instructions

### 2.1 PV Safety Guidelines

- 1.The total open circuit voltage and input DC voltage (PV) must be lower than the maximum DC input voltage (Inverter); otherwise, overvoltage will cause irreversible damage to the inverter, and any damage caused by PV overvoltage is and will not be covered by warranty.
- 2.When installing PV systems, it is essential to include overvoltage protection by using surge arresters. The inverter is already equipped with SPDs on both the PV input and Grid sides. We recommend consulting a professional before installing SPDs.
- 3.Exposing photovoltaic (PV) modules to sunlight produces high direct current (DC) voltage, which poses a risk of electric shock and can lead to serious injuries or even death. Therefore, users should always avoid touching the positive or negative poles of the PV connecting device, and they must never touch both poles at the same time.
- 4.The wiring for the photovoltaic (PV) modules must be performed by individuals with relevant qualifications.

### 2.2 Inverter Safety Guidelines

- 1.Do not power on the inverter until all installation procedures have been fully completed.
- 2.It is essential to use a dedicated power supply line protected by a circuit breaker. Ensure that all wiring maintains a minimum clearance of 3mm for safety.
- 3.The inverter must be properly grounded, and the supply line should be equipped with an appropriate circuit breaker and a Residual Current Device (RCD) to protect the operator.

**Notice: The internal grounding (PE) conductor size of this inverter is [3.3 mm<sup>2</sup>] (12 AWG ).**

- 4.This inverter is not designed for explosive environments. Do not install the inverter in locations that pose an explosion risk.

5. Users should never touch electrical components immediately after disconnecting the power supply. Wait at least 5 minutes before handling any components.

6. This unit does not contain user-serviceable parts. For maintenance or repairs, always consult a qualified technician.

## 2.3 Battery Safety Guidelines

1. Always follow the safety instructions provided in the battery manual when handling the battery. The battery used with the inverter must meet the specified requirements for the inverter series.

2. This inverter is designed to work with low-voltage batteries. For detailed information on battery type, nominal voltage and nominal capacity, please refer to the specification sheet in this manual. Make sure to consult the corresponding battery specifications for more details.

## 3. Parts List

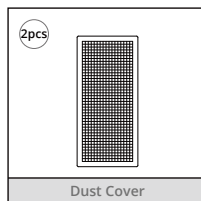
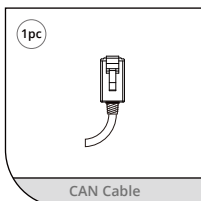
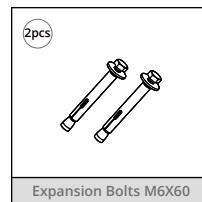
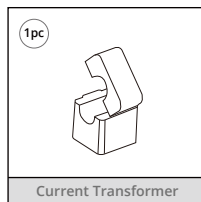
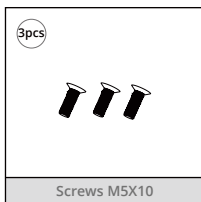
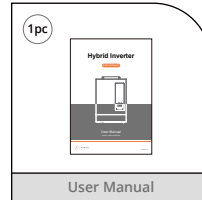
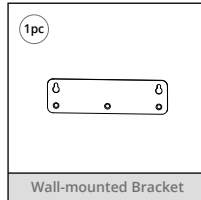
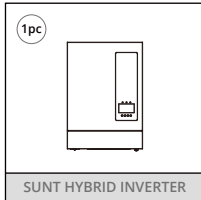

# 4. Product Overview

► **LCD Segment Code Screen:**

The inverter features a user-friendly LCD segment code screen that enables real-time monitoring of system status and basic configuration of all operational settings.

► **Power ON/OFF Switch:**

A DC-DC switch allows the battery to increase its voltage to the high-voltage bus needed to power the inverter's internal circuits, allowing for both inversion and charging functions.

LCD Segment Code Screen

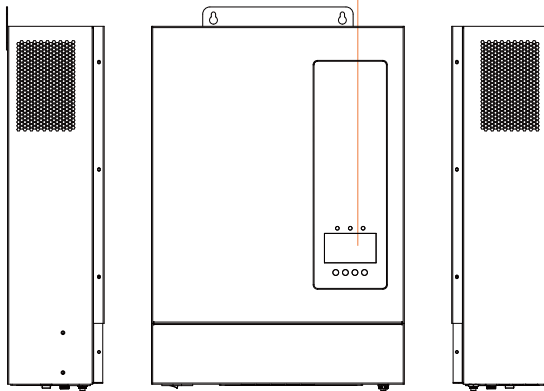

Electrical Connection Area

Power ON/OFF Switch

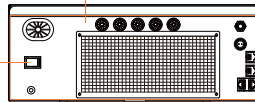

► **Electrical Connection Area:**

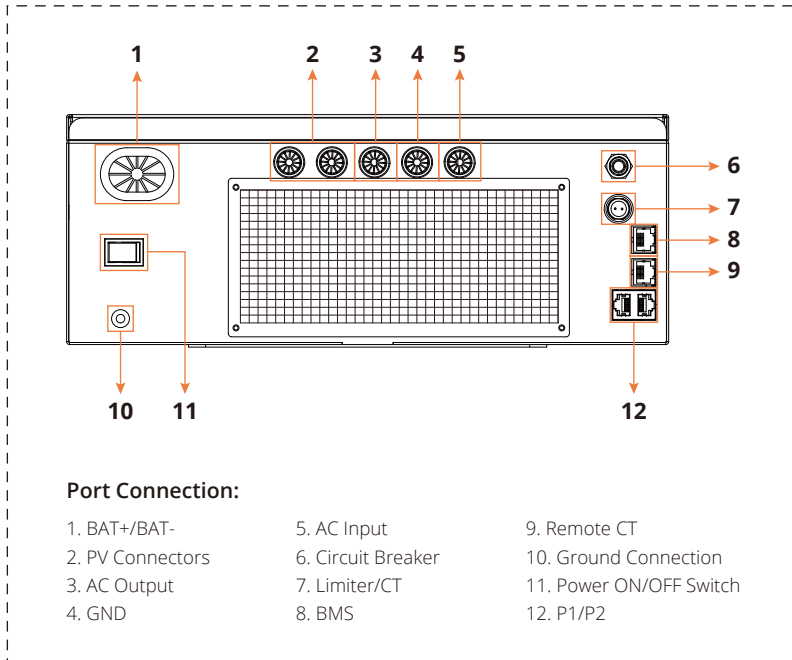

This section includes various terminals for different connections:

- **BAT+/BAT-:** For connecting the battery.
- **PV Connectors:** For connecting the photovoltaic module.
- **AC Output:** For connecting the **Essential load**.
- **GND:** For ground connection.
- **AC Input:** For connecting the electrical grid.
- **Circuit Breaker:** For circuit breaker function.
- **Limiter/CT:** For connecting wired current transformer.
- **BMS:** For connecting battery management system.
- **Remote CT:** For connecting wireless current transformer.
- **Ground Connection:** Ensure proper ground connection for safety and system stability.
- **Power On/Off Switch:** For controlling the battery.
- **P1/P2:** For connecting parallel.

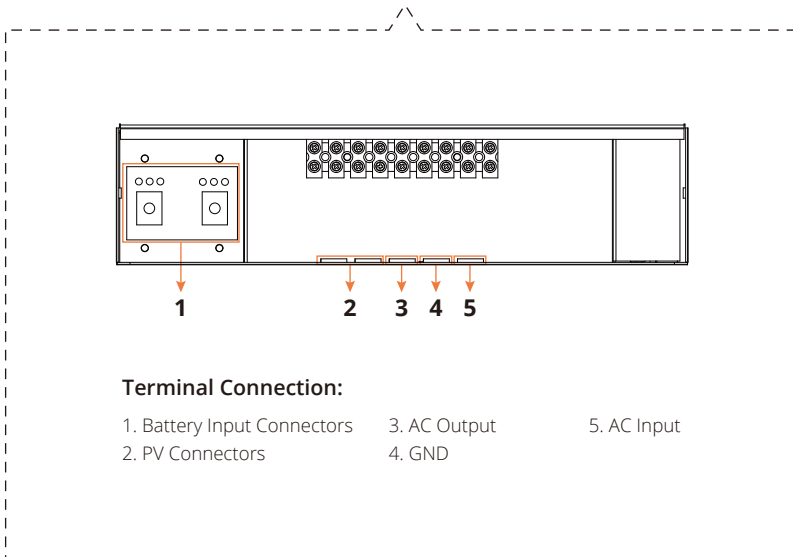
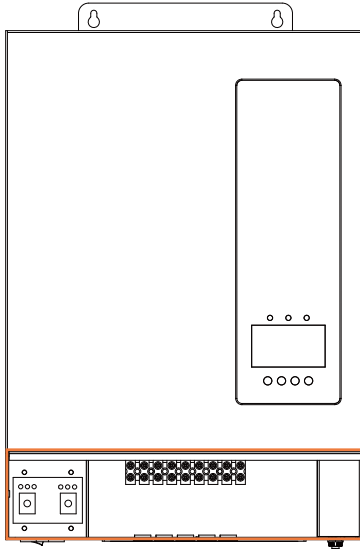

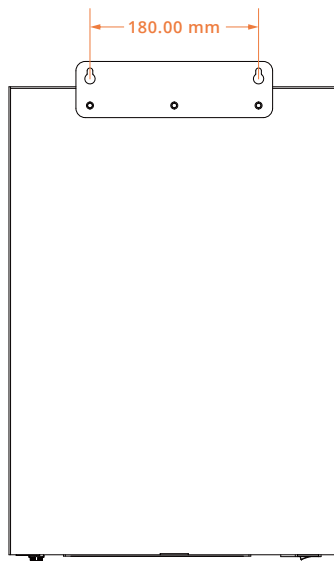
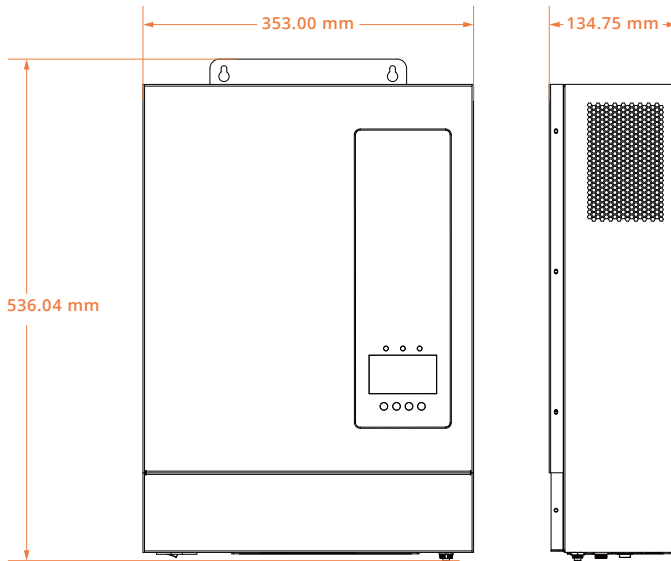

## 5. Installation Location Guidelines

---

To ensure the proper functioning and longevity of the inverter, avoid installing it in the following areas:

**1.High Salt Content Areas:** Locations with a marine environment or high salt content can cause deterioration of metal components, leading to failure or water leakage in the unit.

**2.Oil or Steam-Rich Environments:** Avoid areas such as kitchens or areas where mineral oils or large amounts of splashed oil or steam may be present. These conditions can degrade plastic parts and lead to failure or water leakage.

**3.Corrosive Gas Environments:** Do not install the inverter in areas where sulfuric gas, chlorine gas, acids or alkalis are present. These substances can corrode copper pipes and brazed joints, potentially causing refrigerant leaks.

**4.Explosive or Flammable Environment:** Do not install the unit where combustible gases may leak, or in environments with suspended carbon fibers, flammable dust or volatile inflammables such as paint thinner or gasoline. These conditions may cause fire hazards.

**5.Gas Leak Risk Areas:** Avoid locations where gas leaks may occur or settle around the unit, as this could create a fire risk.

**6.Animal Exposure Areas:** Do not place the unit where animals may urinate on it or where ammonia could be generated, as this could damage the unit.

**7.High Altitudes:** Do not install the inverter at altitudes higher than **3000 meters (9843 feet)** above sea level, as this may affect its performance.

**8.Low Air Circulation Areas:** Avoid installing the inverter in locations with poor ventilation, as adequate airflow is essential for proper heat dissipation.

**9.Direct Exposure to Sun, Rain or Snow:** The unit should not be exposed to direct sunlight, heavy rain or snow accumulation, as this can damage the system.

**10.Flammable or Explosive Materials:** Do not install the inverter near flammable, explosive, or corrosive materials, or near antennae.

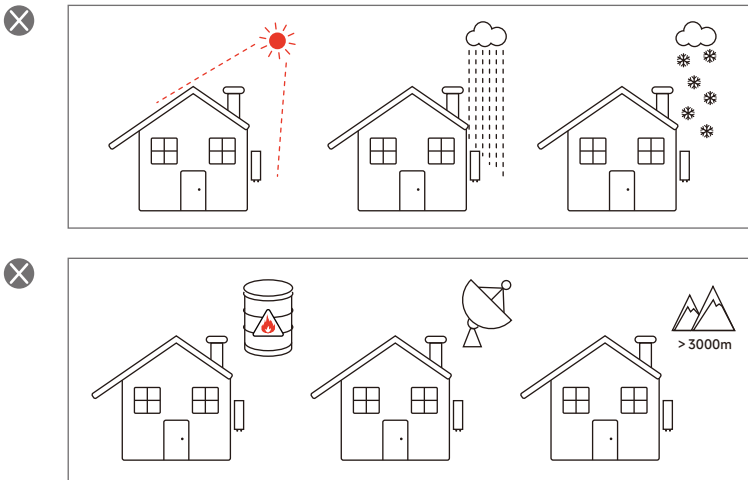

► **Additional Installation Considerations:**

**1.Distance from TV/Radio Receivers:** Install the indoor unit, outdoor unit, power supply cable, transmission cable and remote control cable at least **1 meter (3.3 feet)** away from television or radio receivers. This prevents interference with TV reception and radio noise. Even with a distance of 1 meter, interference may still occur under certain signal conditions.

**2.Child Safety:** If children under 10 years old may be in proximity to the unit, take precautions to prevent them from coming into contact with it.

**3.Indoor Unit Height:** Install the indoor unit at a height of **160cm (5.3 feet)** from the floor for optimal performance and ease of access.

► **Environmental Conditions for Installation:**

**Ambient Temperature Range:** The inverter should be installed in an environment where the ambient temperature is between **-25°C to 60°C**.

**1. Please note that the SUNT-6.0kW-HP hybrid inverter should be installed indoors.**

**2.Ventilation:** It is important to install the inverter in a location that allows for sufficient ventilation to promote effective heat dissipation. If the inverter is mounted outdoors, it is recommended to install an awning or similar protection to shield it from harsh weather conditions.

**3.Suitable Mounting Surface:** Ensure the inverter is installed on a vertical, load-bearing wall, preferably made of concrete or another non-flammable material.

**4.Optimal Viewing:** Install the inverter at eye level for easy viewing of the LCD display.

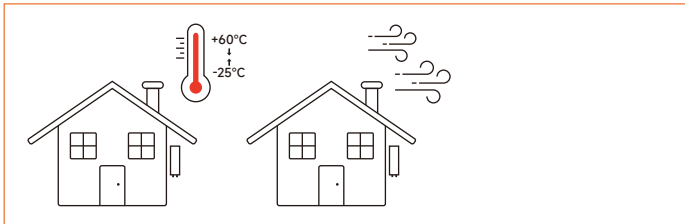

**5. Clearances for Air Circulation:** To facilitate proper air circulation and prevent overheating, allow a clearance of **approximately 50cm (19.7 inches)** on each side, **50cm above** and **below** the unit, and **100cm in front**.

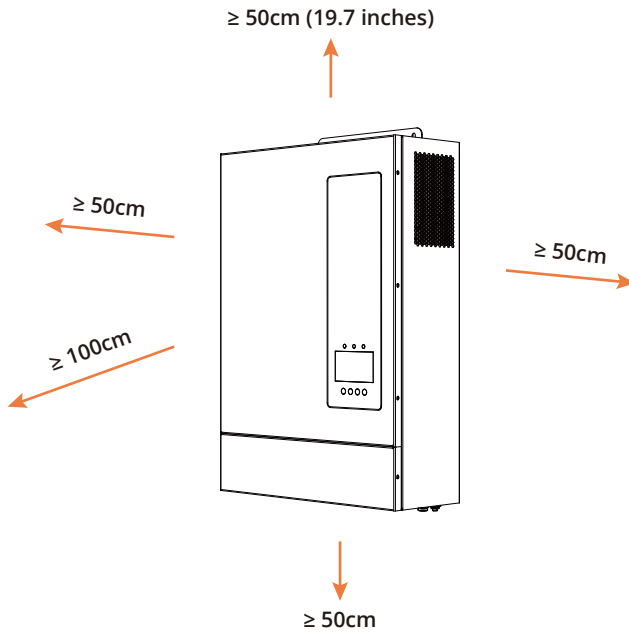

The guidelines in this chapter are crucial for ensuring that the inverter operates efficiently and safely.

# 6. Mounting Instructions

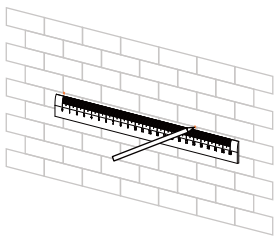
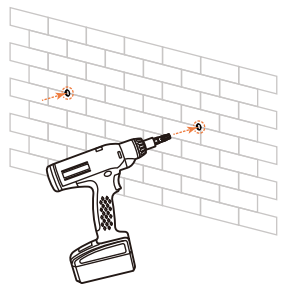
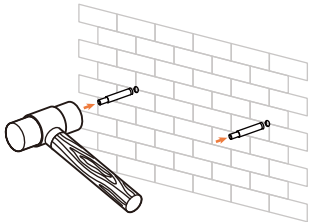
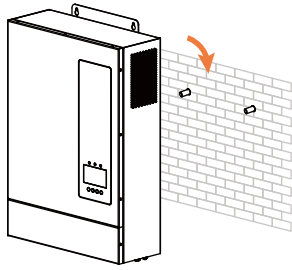
<p><b>1</b></p>  <p>Mark the drill positions using the metal plate on the back of the inverter. Measure carefully to ensure proper alignment.</p>	<p><b>2</b></p>  <p>Drill two holes, each 10mm (0.39 inch) wide and 51–56mm (2–2.2 inches) deep.</p>
<p><b>3</b></p>  <p>Use a hammer to insert the expansion bolts into the holes, ensuring they are securely seated.</p>	<p><b>4</b></p>  <p>Hang the inverter onto the wall-mounted expansion bolts, making sure it is securely in place.</p>

# 7. Connection

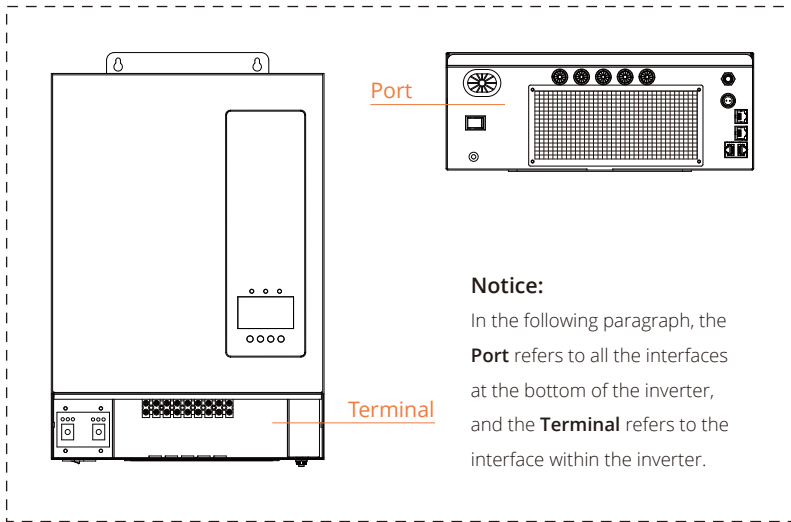

### Notice:

In the following paragraph, the **Port** refers to all the interfaces at the bottom of the inverter, and the **Terminal** refers to the interface within the inverter.

## 7.1 PV Connection

### 7.1.1 PV Module Selection

1. Calculate **Open Circuit Voltage (Voc)**: Ensure the **total Voc** of each MPPT string is between **150V** and **500V**. Exceeding 500V may damage the inverter and should be strictly avoided.
2. Determine Power Requirements: The maximum DC input power is **8000W**.
3. Use PV modules of the same model within the same MPPT channel.
4. Ensure uniform quantity, alignment and tilt within each string.
5. Use positive cables of the PV modules to connect positive DC connectors, and negative cables of the PV modules to connect negative DC connectors.
6. Check PV Array Voltage: Use a multimeter to measure the voltage of the PV array. If abnormalities are detected, fix them before proceeding.

### 7.1.2 PV Cable Selection

We recommend the following wire specifications for a 6.0kW hybrid inverter:

- Wire Size: **10AWG**
- Maximum Current: **23.7A**
- Cable Cross-Section Size: **5.2mm<sup>2</sup>**

### 7.1.3 Steps to Connect the PV to the Inverter

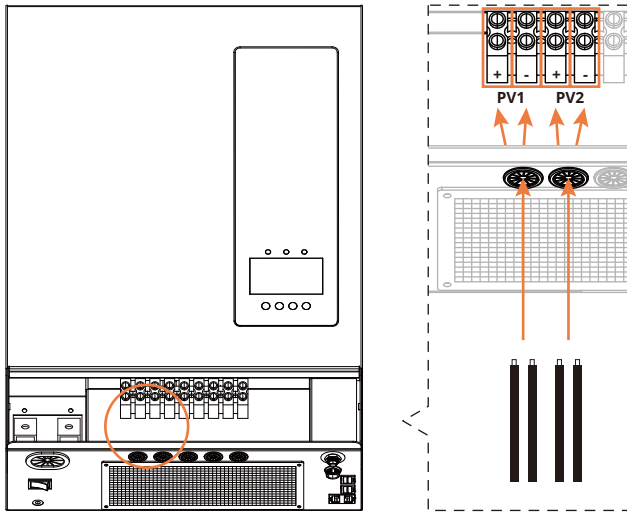

**1.Strip the Cable:** Remove the insulation from the PV cable to the required length, ensuring it fits properly into the PV terminal.

**2.Unscrew the PV Terminal:** Loosen the screw on the PV terminal to prepare for the cable insertion.

**3.Insert the Cable:** Fully insert the stripped PV cable into the PV terminal, ensure the positive cable into the PV+ terminal and the negative cable to the PV- terminal, and tighten the screw with a screwdriver to secure the connection.

**4.Check the Connection:** Gently pull the cable to confirm the connection is secure.

**5. Check Polarity:** Confirm polarity alignment between the PV and inverter. Please ensure that the positive terminal of the PV is connected to the positive terminal of the inverter, and the negative terminal of the PV is connected to the negative terminal of the inverter.

## 7.2 Battery Connection

### 7.2.1 Battery Selection

1. Compatible with **LiFePO4** and **lead-acid** batteries.
2. Battery input voltage must be between **40V** and **60V**.
3. Prefer batteries with a Battery Management System (BMS) for enhanced safety.

### 7.2.2 Battery Cable Specifications

Recommended specifications for the battery cable:

- Wire Size: **2AWG**
- Maximum Current: **151.3A**
- Cable Cross-Section Size: **33.6mm<sup>2</sup>**

### 7.2.3 Precautions Before Connecting

- Ensure the **breaker, power button** (if applicable) and **DC switch** (if applicable) of the battery are all turned off.
- Verify **correct polarity** to avoid causing damage to the inverter.
- If a battery includes an **internal DC breaker**, no additional breaker is required unless mandated by local regulations.

### 7.2.4 Steps to Connect the Battery

**1. Cable Selection:** Select an appropriate cable with connectors compatible with the battery terminals.

**2. Insert Cable:** Insert the battery cable through the BAT+ and BAT- ports, positioning it directly above the battery terminal.

**3. Attach Cable:** Remove the screws from the battery terminal, attach the battery cable to the terminal, ensure the positive cable into BAT+ terminal and the negative cable to BAT- terminal, use a screwdriver to tighten the screws.

**4. Check Polarity:** Confirm polarity alignment between the battery and inverter. Please ensure that the positive terminal of the battery is connected to the positive terminal of the inverter, and the negative terminal of the battery is connected to the negative terminal of the inverter.

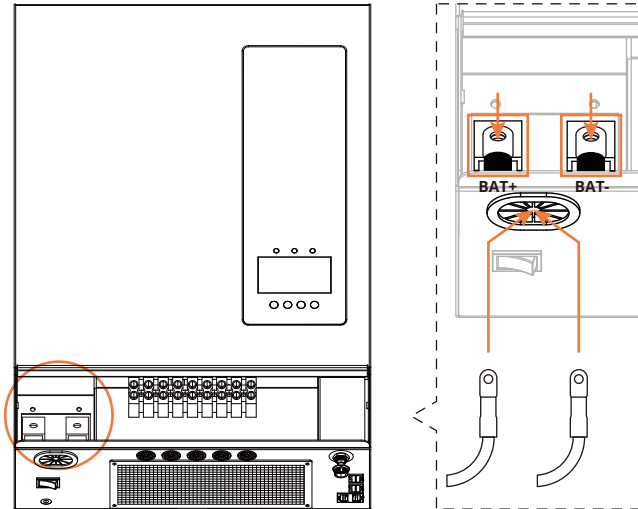

## 7.2.5 BMS Communication

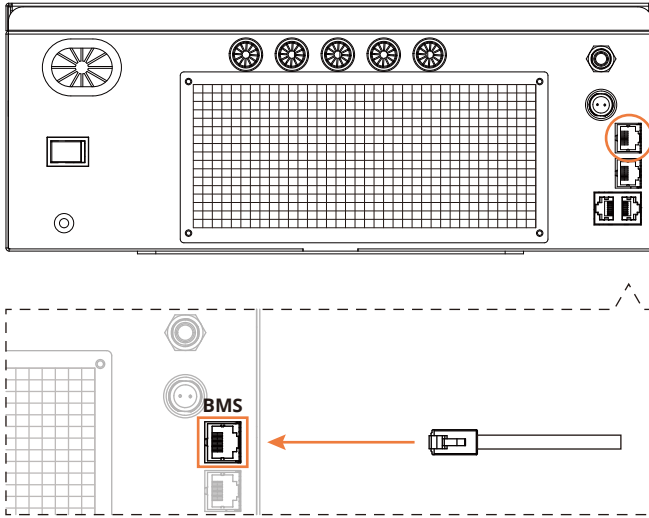

### How to Connect the BMS Communication Cable:

**Insert the Cable:** Connect the cable within the package to the BMS port.

Our inverters use the **CAN 500kbps** and **CAN 250kbps** protocols for communication with BMS- equipped batteries. The communication cable is included in the inverter package. For the exact protocol supported, please visit [http://www.lumentree.co/?list\\_42/](http://www.lumentree.co/?list_42/), or scan the QR code below.



## 7.3 AC Input and AC Output Connection

### 7.3.1 AC Input and AC Output Cable Selection

We recommend using the following specifications:

- Wire Size: **8AWG**
- Maximum Current: **37.7A**
- Cable Cross-Section Size: **8.3mm<sup>2</sup>**

### 7.3.2 AC Input and AC Output Wiring

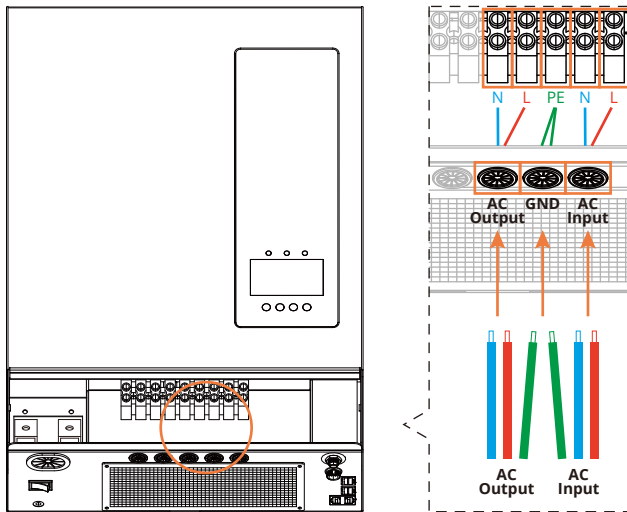

For proper operation, it is essential to correctly connect the live wire, neutral wire and ground wire to the corresponding terminal on the inverter.

## **Wiring Procedure:**

### **1.Preparation:**

- Ensure that the inverter and all associated equipment are powered off and disconnected from the electrical supply before proceeding with any wiring.
- Strip the insulation from each wire to the appropriate length to fit the corresponding terminal.

### **2.Connecting Wires to the Inverter:**

- Using a suitable screwdriver, loosen the screw on each terminal (**AC Input, AC Output, GND**).
- Insert the stripped wires into the corresponding terminal (**AC Input, AC Output, GND**). Ensure each wire is inserted correctly according to its polarity.
- Tighten the screws with a screwdriver.

### **3.Double-Check Connections:**

Verify that the live wire, neutral wire and ground wire are securely connected to their designated terminals. Incorrect connections may result in system malfunction, electrical hazards or equipment damage.

## **Notice:**

### **1.Install an AC Circuit Breaker**

To ensure safety, users should place an AC circuit breaker (AC switch) between the inverter and the grid.

### **2.Add a Load Disconnection Device**

A load disconnection device should be installed for each inverter to allow safe disconnection while under load.

## 7.4 Wire Current Transformer (CT) Connection

The Current Transformer (CT) is a key component of the hybrid inverter system, used to monitor and manage electricity flow. Each inverter is supplied with one CT.

### 7.4.1 Important Installation Guidelines

**1. Arrow Direction:** Place the CT clamp on the **live wire (L)**, ensuring the arrow points toward the inverter.

**2. Avoid the following Mistakes:**

- Do not place the CT on the neutral (N) or ground (PE) wire.
- Do not place the CT on both neutral (N) and live (L) wires together.

**3. Use Insulated Wires Only:** The CT must not be installed on bare wires.

**4. Safety Tip:** Wrap the CT clip with insulating tape for extra protection.

The CT coil is essential for features like the "Zero Export" function, which prevents power from being sent to the grid by reducing the inverter's output power. Additionally, the CT is imperative for enabling the function of AC coupling, for receiving power from the existing micro or string inverters.

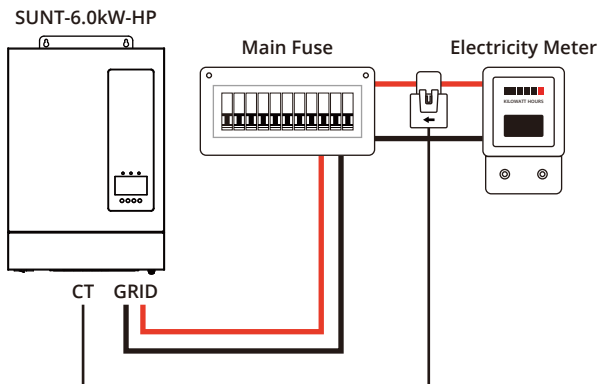

### 7.4.2 Installation Steps

**1. Positioning the CT:** Place the CT clamp on the **live wire** coming from the main fuse that supplies power to the building.

**2.Cable Extension:** If needed, contact us for extended current transformers.

**3.Connecting to the Inverter:** Insert the CT into the corresponding port and tighten the screw cap on the CT to secure the connection.

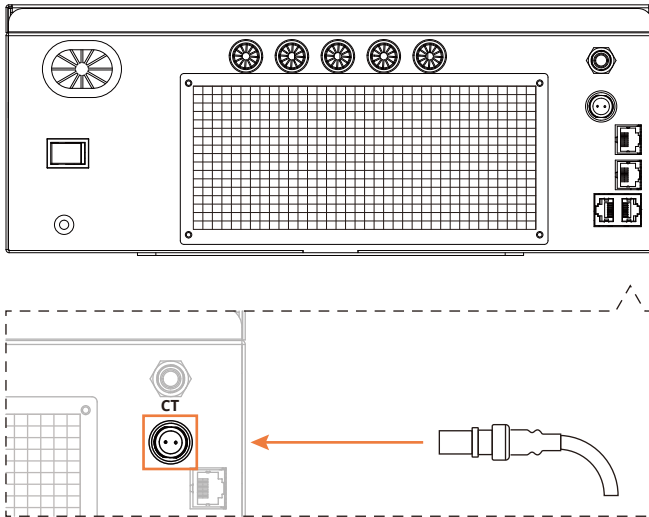

### 7.4.3 Important Note

If the CT coil is installed incorrectly (with the arrow pointing in the wrong direction), the "AC CT Power" on the LCD segment code screen will display negative power readings. When installed correctly, it will show positive power readings. Incorrect installation will prevent the inverter from properly controlling the amount of power sent back to the grid. To correct this, remove the current transformer (CT) and reinstall it in the reverse direction.

## 7.5 Parallel Connection

**Notice:** It is recommended that the maximum number of inverters connected in parallel should not exceed 6 units.

The following diagram illustrates the process of connecting multiple inverters in parallel.

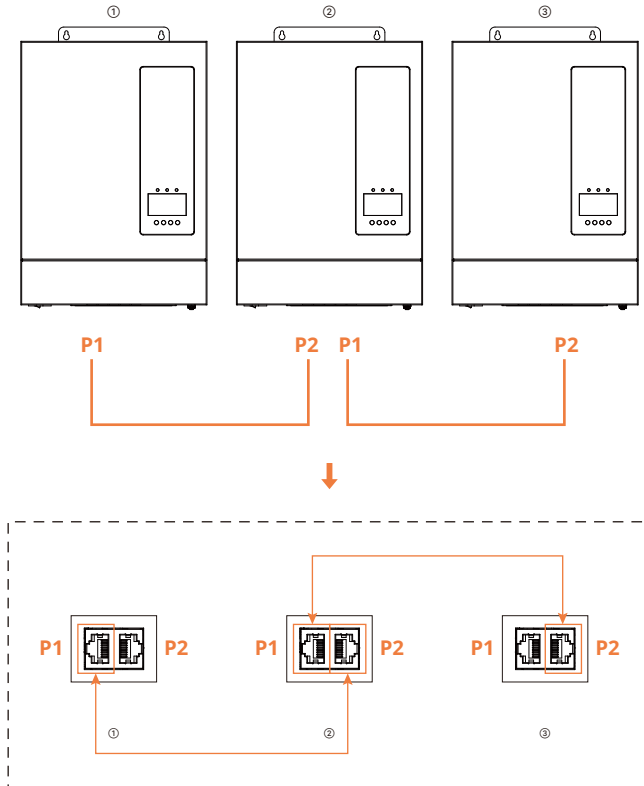

**First to Second Inverter:** Connect the first inverter to the second using communication cable, ensuring the cable is plugged into the correctly labeled terminal as shown in the diagram above.

**Second to Third Inverter:** Connect the second inverter to the third using communication cable, ensuring the cable is plugged into the correctly labeled interfaces as shown in the diagram above.

## SUNT Hybrid Inverter Multiple inverters working together:

Consist a **single-phase** system.

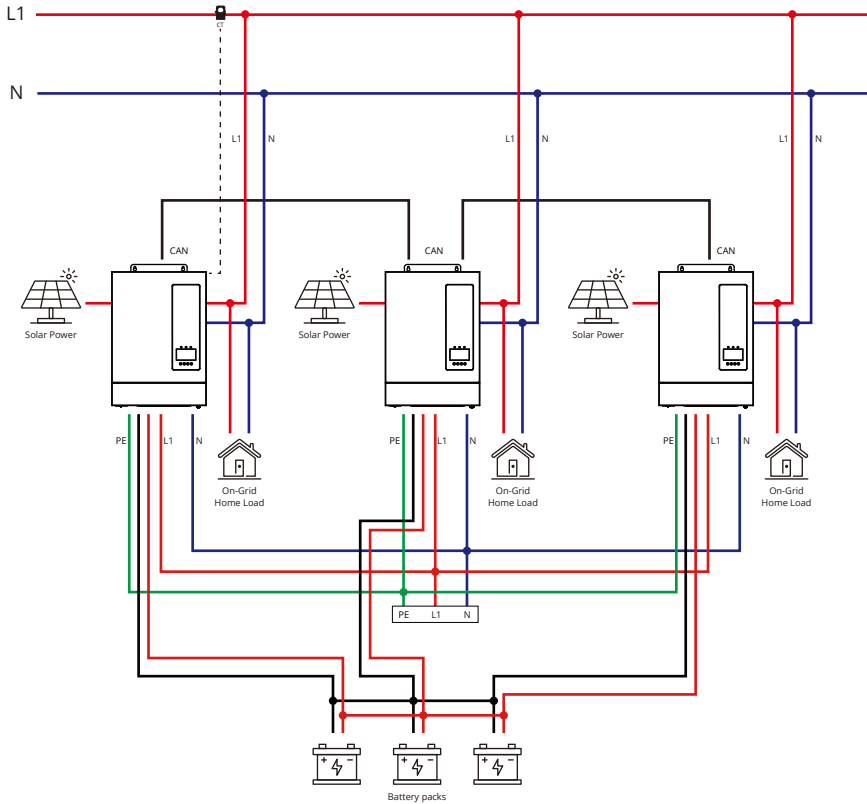

Battery packs need to be connected in parallel,  
positive polars connected together  
and negative polars conected together.

## Operating Guide:

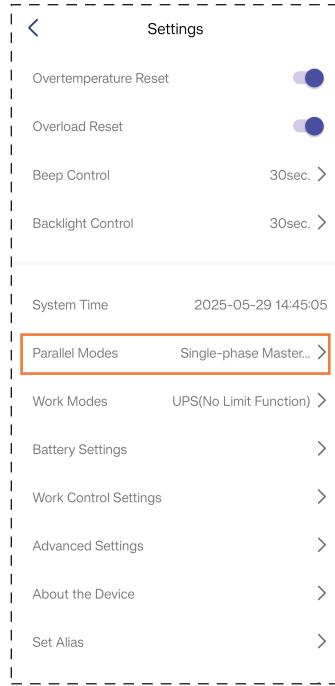
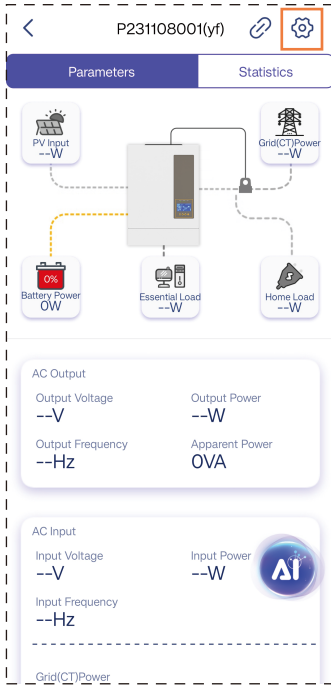

1. Open the LightEarth app and connect to the first inverter via Bluetooth or WiFi. Then tap the "⚙️" icon in the top right corner of the app.

2. Tap on the "Parallel Modes".

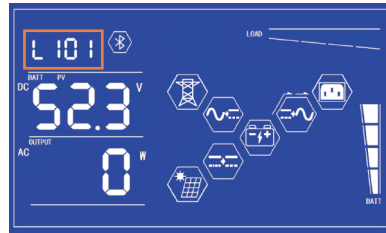
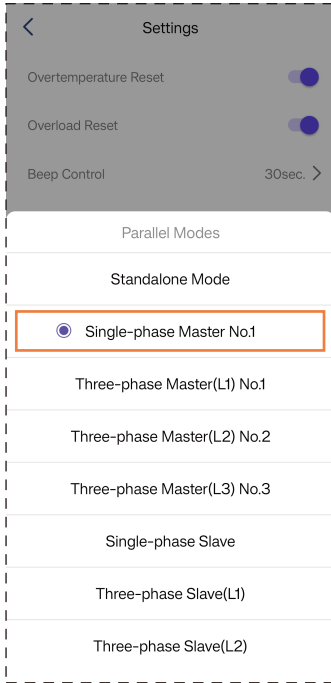

At this point, the segment code display will show "L101", indicating that the master inverter has been successfully configured.

3.Set the first inverter's mode to "**Single-phase Master No.1**".

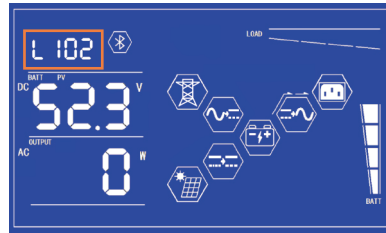
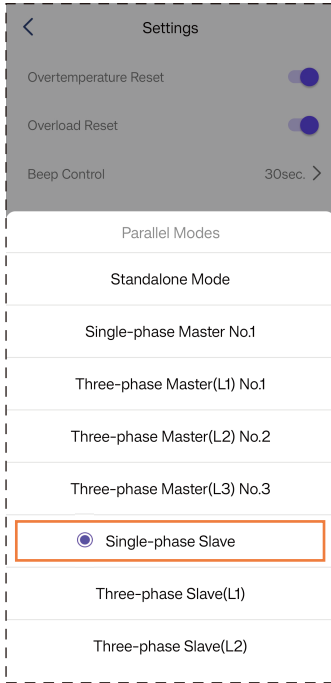

At this point, the segment code display will show "L102", indicating that the slave inverter has been successfully configured.

4. Open the LightEarth app and connect to the second inverter via Bluetooth or WiFi. Then, in the Parallel Modes section, set the mode to **"Single-phase Slave"**.

## SUNT Hybrid Inverter Multiple inverters working together:

Consist a **three-phase** system.

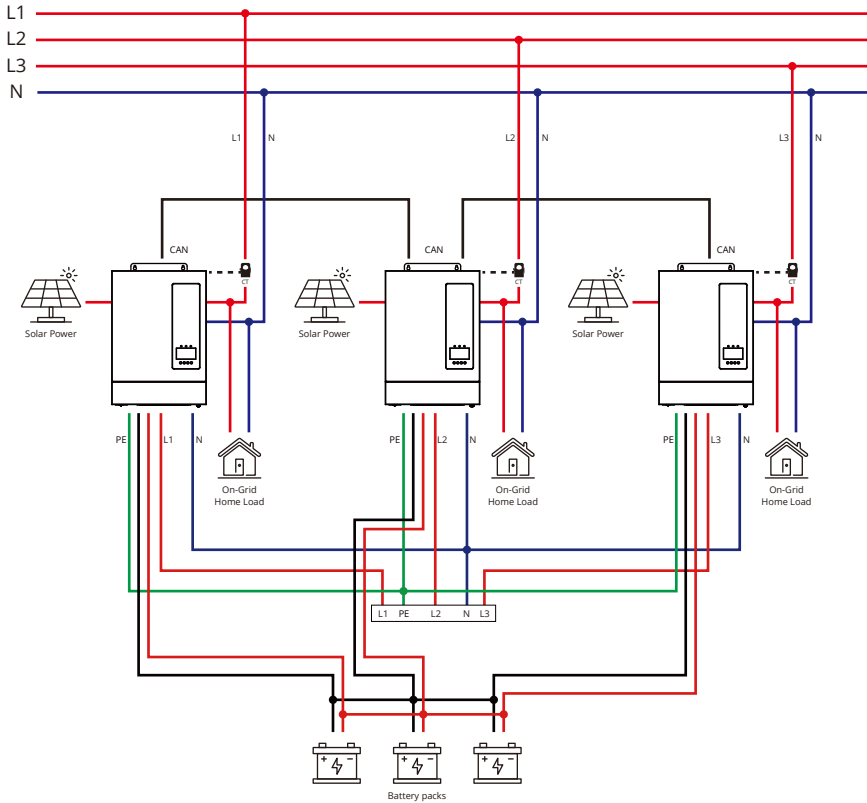

Battery packs need to be connected in parallel,  
positive polars connected together  
and negative polars conected together.

## Operating Guide:

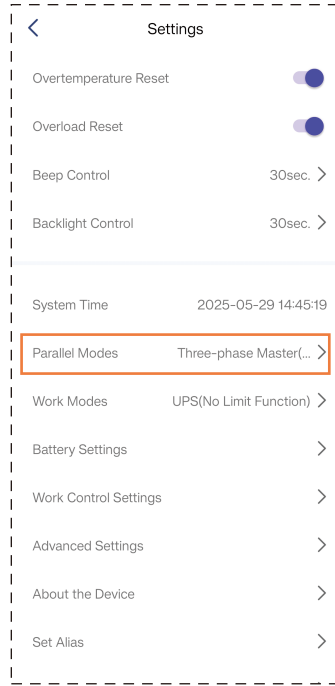
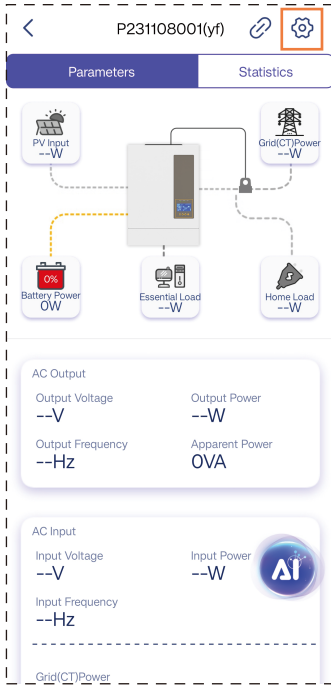

1. Open the LightEarth app and connect to the first inverter via Bluetooth or WiFi. Then tap the "⚙️" icon in the top right corner of the app.

2. Tap on the "**Parallel Modes**".

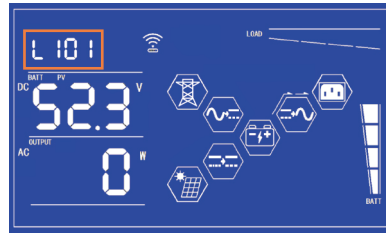
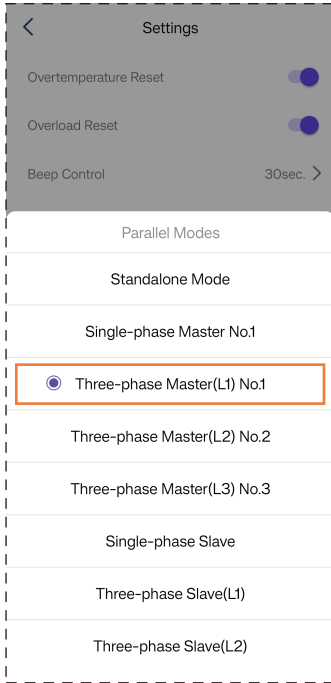

At this point, the segment code display will show "L101", indicating that the master inverter has been successfully configured.

3. Set the first inverter's mode to **"Three-phase Master(L1) No.1"**.

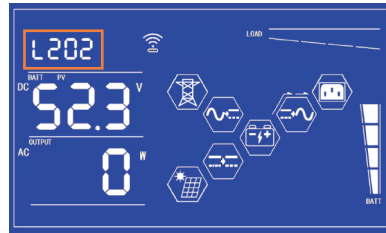
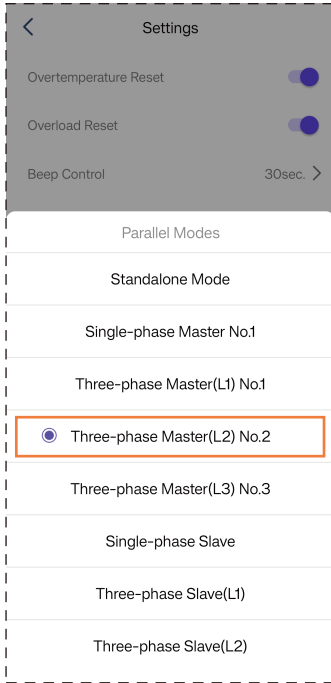

At this point, the segment code display will show "L202", indicating that the slave inverter has been successfully configured.

4. Open the LightEarth app and connect to the second inverter via Bluetooth or WiFi. Then, in the Parallel Modes section, set the mode to **"Three-phase Master (L2) No.2"**.

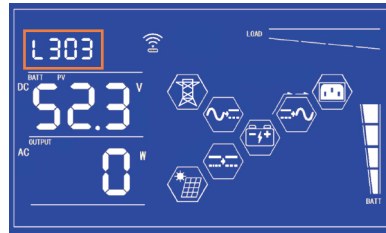
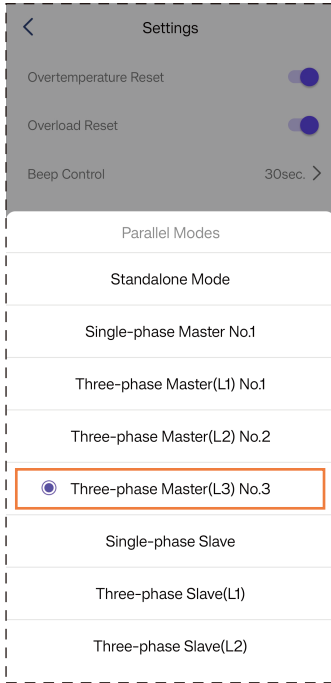

At this point, the segment code display will show **"L303"**, indicating that the slave inverter has been successfully configured.

5. Open the LightEarth app and connect to the third inverter via Bluetooth or WiFi. Then, in the Parallel Modes section, set the mode to **"Three-phase Master (L3) No.3"**.

After changing the inverter's standalone or parallel mode, the device will automatically switch its operating mode within three minutes. During this process, an E13 error may appear—this is normal.

If the inverters fail to operate in parallel after the mode has been set, try turning off all units. Then, power on all the inverters intended for parallel operation within five seconds. Once the devices are running, check if the parallel connection has been successfully established.

**Notice:**

Follow the standard settings sequence during initial setup.

**Installation Complete Indicators:**

When the grid is connected, a blue light on the LCD Segment Code Screen interface under "AC/INV" indicates successful installation.

When the grid is not connected, a green light on the LCD Segment Code Screen interface under "AC/INV" signifies successful installation.

Occasionally, the phase configuration of the three-phase inverter system may change. If the system does not provide the correct feedback, please try the following adjustments:

**1.Set Second Inverter:** Configure the second inverter as **Master (L3)**.

**2.Set Third Inverter:** Configure the third inverter as **Master (L2)**.

If the power of a three-phase system consisting of three inverters in parallel is still insufficient, additional slave units can be connected to the master unit of each phase. The number of slave units connected to each phase must be the same. It is recommended that the total number of inverters in the system not exceed **six**.

## 7.6 Ground Point Connection

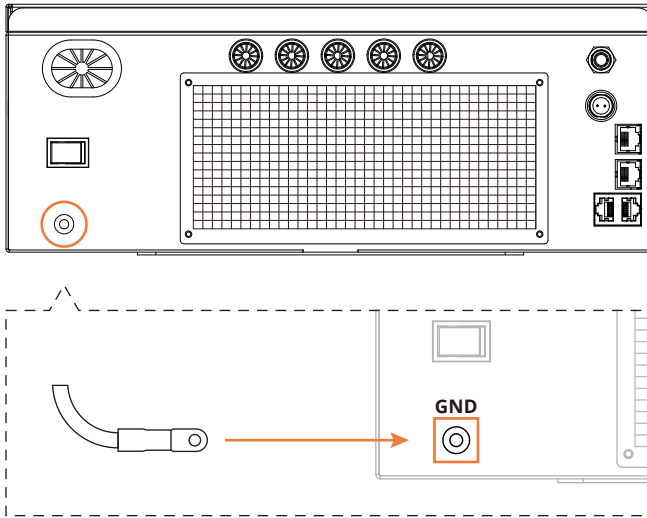

Follow these steps to ensure a proper ground connection:

- 1.Loosen the Screw:** Use a screwdriver to unscrew the screw in the connection area.
- 2.Attach the Wire:** Connect the wire securely to the ground point.
- 3.Secure the Connection:** Tighten the screw with the screwdriver to firmly fix the wire in place.

### Safety Notice:

- **Ensure Proper Grounding:** Always make sure the inverter is properly grounded to prevent electrical hazards. (This inverter is suitable for TN earthing systems; PE must be earthed; Internal N-PE bonding is strictly prohibited)
- **Power Off Before Connecting:** Always ensure the system is powered off before performing any electrical connections to prevent the risk of electric shock.

**Important:** Following these safety guidelines helps protect you and ensures the reliable operation of your system.

## 7.7 Steps to Turn On/Off the Inverter

### Turn On

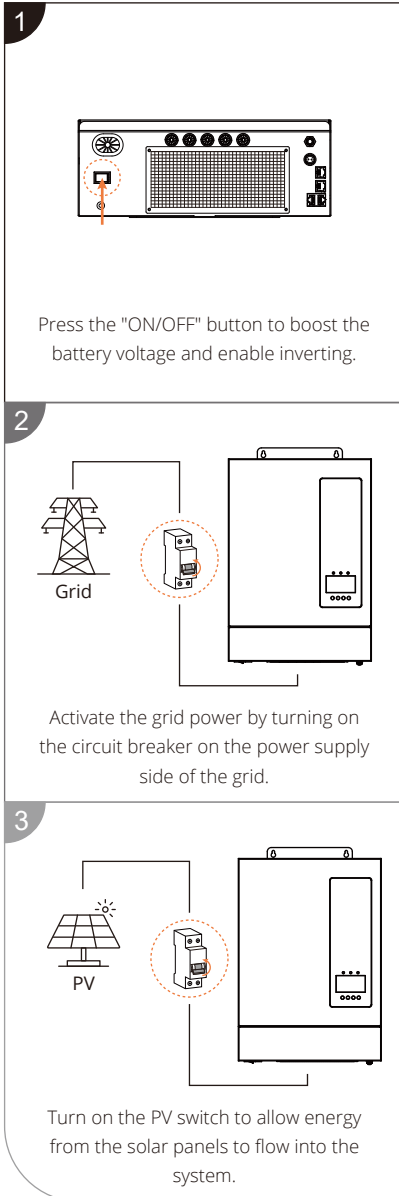

### Turn Off

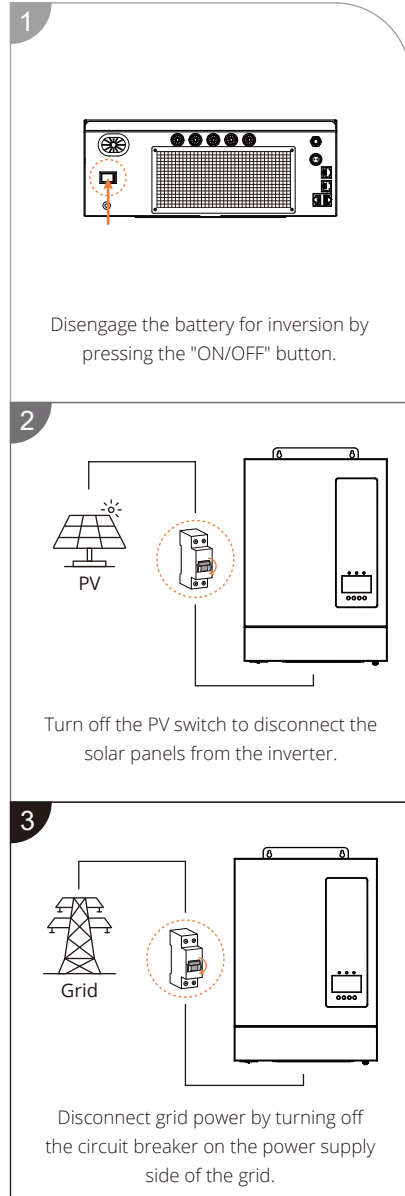

## 8. System Overview

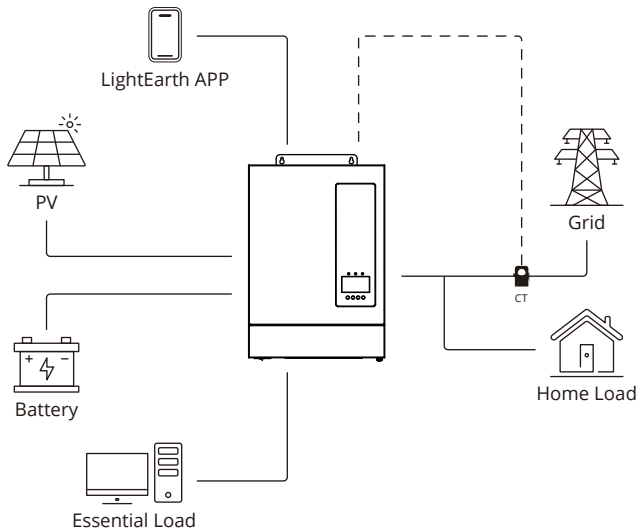

The **SUNT-6.0kW-HP** inverter is a cutting-edge energy storage solution, specifically designed to optimize the grid integration of **photovoltaic (PV)** systems.

### ► Photovoltaic Modules:

The inverter operates in **Maximum Power Point Tracking (MPPT)** method and is equipped with **dual MPPTs**, enhancing system efficiency by ensuring optimal power generation under various environmental conditions.

### ► Battery System:

The **SUNT-6.0kW-HP** inverter is compatible with **low-voltage batteries** (both **lithium** and **lead-Acid**), the SUNT-6.0kW-HP series allows the installation of batteries with identical capacities and models. The inverter communicates with the battery via a **Battery Management System (BMS)**, ensuring compliance with industry standards and regulatory requirements.

► **Current Transformer (CT):**

The integrated **CT** enables the inverter to track energy import/export and consumption, facilitating efficient battery charge and discharge management for optimized energy use.

► **Grid Compatibility:**

The inverter is compatible with grid voltages of 220V, 230V and 240V, making it suitable for various electrical systems. The parameters can be adjusted based on the installation country to better accommodate the local grid requirements.

► **LightEarth:**

The **LightEarth** serves as a smart, versatile monitoring tool that offers remote access. Through the LightEarth platform, both operators and installers can access vital information and stay updated on system performance, while also allowing them to control and adjust parameters to regulate the energy flow remotely, either via Bluetooth or Wi-Fi. Users can download the app using the QR code below.



# 9. LCD Screen Overview

## 9.1 LED Overview



Type	Color Indicator	Description
AC/INV	● BLUE	The inverter is active and connected to the grid.
	● GREEN	The inverter is active in off-grid mode.
CHARGE	● YELLOW	Battery is charging.
	● OFF	Battery is not charging.
FAULT	● RED	A fault has occurred. The light stays on until the fault is cleared or the system is restarted.
	● OFF	System is functioning normally.

## 9.2 Main Interface Overview

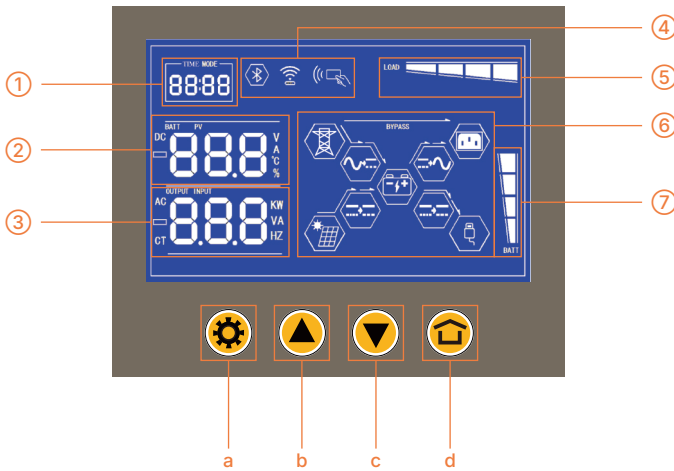



a: Setting	b: Up	c: Down	d: Home
------------	-------	---------	---------

For detailed operations and functions of these four buttons, please refer to the following sections of this chapter, which will provide specific setup instructions.



①: This area displays the real-time and the number of settings displayed during the setting process.

②: This section displays information about the connected batteries and solar modules, including the solar module's working voltage and current, the battery's voltage, capacity, charging and discharge currents, as well as the unit's internal temperature.

Operation to change display contents:

The display content of this part can be switched by pressing the two buttons  or  on the left.

③: This section shows information about the AC input and output while the unit is operating, including the inverter's AC output voltage, current, power (KW and KVA), as well as the AC input power voltage, current, frequency, and power.











The display content of this part can be switched by pressing the two buttons  or  on the left.

④: This area shows whether the machine is connected to Bluetooth or WIFI. Each models of the machine display different contents in this part. Display icon, that there is a corresponding function, otherwise do not display.

⑤: This area displays the total power of the load. The greater the load power, the more the number of bars displayed, and vice versa.

⑥: This area shows the operating status of the machine. The corresponding arrows indicate the direction of energy flow. When the corresponding arrow flashes, it means that the energy in this part is flowing in the direction of the arrow.

⑦: This area displays the battery capacity. The larger the battery capacity, the more bars are displayed, and vice versa.

	Utility grid.		Connected solar module.
	AC output.		Batteries connected.
	DC load.		The AC bypass module.
	The internal AC charging module of the machine, that is, charging the battery through the power grid.		
	The DC-DC module, connected to the solar module, represents the MPPT charging module inside the machine.		
	The DC-DC module adjacent to the DC load is the DC output module inside the machine. (Note: This feature is customizable, not standard.)		
	Represents the internal inverter module of the machine, which converts the input DC into AC output.		

### Machine function and parameter setting:

When you press  for about 3 seconds, it will enter the configuration interface, you can build all configurations by using these four buttons.







Short press , you can select the configuration page that you want to set up.

Short press , you can select the number that you want to change on the same page.

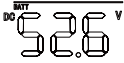

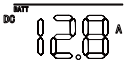
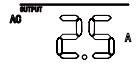
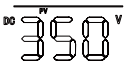
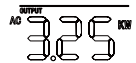
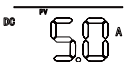
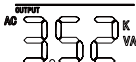
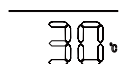

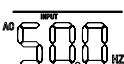
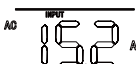

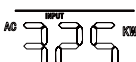





Short press  and , you can change the content that you selected.



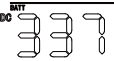

Press  long than 2S, then the configuration page will return back to the previous page.

When you finish the configurations, then you can press  for about 3 seconds to quit, or you just stop pressing any button, then the configuration procedure will quit automatically in about 10 seconds.

LCD Display	Function	LCD Display	Function
	Battery voltage		AC output voltage (Inverter)
	Battery charge /discharge current Positive number is discharge current, negative number is charge current		AC output current (Inverter)
	PV voltage		AC output power(KW) (Inverter)
	PV current		AC output power(KVA) (Inverter)
	Internal temperature		AC input voltage (Grid)
	AC input frequency		AC input current negative number is current feeding to grid.
	CT detected power(KW)		AC input power(KW) negative number is power feeding to grid.

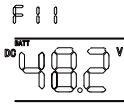
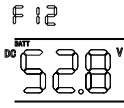
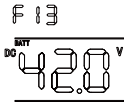
► There are many configurations that you can set up:

Function	Descriptions	Options	Factory Default Setting
F01 	Backlight setting	00:The backlight will automatically turn off after 30 seconds 01:The backlight is always on	01
F02 	Alarm sound setting	00:Turn on the sound alarm 01:The sound is automatically turned off after 30 seconds 02:The sound is always going on	01
F03 	Parallel Modes	00:Standalone mode 01:Single phase host mode 02:Split-phase host mode 03:Three-phase host mode 04:Slave mode	00
F04 	Parallel Modes Address		01
F05 	Overload protection restarts setting	00:Disable 01:Enable	01
F06 	Over temperature protection restarts setting	00:Disable 01:Enable	01
F07 	Battery type setting	00:User 01:Battery pack	00
F08 	Battery capacity setting (AH)	Short press  button, number plus 1, long press  button, quick continuous plus, short press  button, number minus 1, long press  button, quick continuous minus.	100
F09 	Work mode setting	00:UPS mode 01:Zero Export mode	00
F10 	AC coupling	00:Disable 01:Enable	00

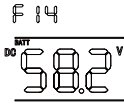
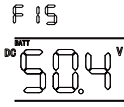
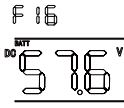
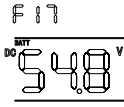
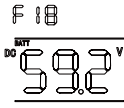
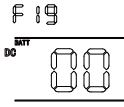
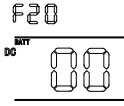
Function	Descriptions	Options	Factory Default Setting
F11 	Grid Type	00:220V 01:230V 02:240V	01
F12 	Frequency setting	00:50Hz 01:60Hz	00
F13 	Battery low voltage protection setting	Short press  button, number plus 1, long press  button, quick continuous plus, short press  button, number minus 1, long press  button, quick continuous minus.	45.0
F14 	Max. discharge current (to loads) setting (If there is PV power available, the battery discharge current will be smaller than this setting value)		100
F15 	Recovery voltage setting		50.0
F16 	Boost charge voltage setting		56.0
F17 	Float charge voltage setting		56.0
F18 	Equalize charge voltage setting		57.0
F19 	Equalize charge time setting (minutes)		60
F20 	Equalize charge interval time setting (Days)		90

Function	Descriptions	Options	Factory Default Setting
F21 	Maximum charge current setting	Short press  button, number plus 1, long press  button, quick continuous plus, short press  button, number minus 1, long press  button, quick continuous minus.	50.0
 F22	Real-time setting	Short press  button to switch between minutes and hours, short press  button, number plus 1, long press  button, quick continuous plus, short press  button, number minus 1, long press  button, quick continuous minus.	
F23 	Max. discharge homeload current (The battery discharges to the loads)	Short press  button, number plus 1, long press  button, quick continuous plus, short press  button, number minus 1, long press  button, quick continuous minus.	120
F24 	Charge From AC	00:Disable 01:Enable	00
F25 	Voltage/SOC	00:Voltage 01:SOC	00
F26 	Low voltage protection		25%
F27 	Battery recovery voltage	Short press  button, number plus 1, long press  button, quick continuous plus, short press  button, number minus 1, long press  button, quick continuous minus.	25%

### Remarks:

- If overload protection restart is set to Enable mode, the AC output will be automatically restored in 5 minutes after the device enters overload protection. If it is set to Disable, the system will not restart.
- If overtemperature protection restart setting is set to Enable mode, when the device is in overtemperature protection mode, the AC output automatically recovers after the device cools down to normal temperature. If it is set to Disable, the system will not restart.
- F03 and F04 functions are designed for parallel operation. However, for the SUNT-6.0kW-HP model, parallel functionality is not supported. Therefore, select "Standalone Mode" under F03 and leave F04 unselected.

# 10. Work Mode Overview

---

## 10.1 Essential Load & Home Load

In our system, loads are classified into two categories: **Essential Load** and **Home Load**.

Below is a detailed explanation of each category and connection methods.

### ► Essential Load:

Electrical appliances connected to the system's "**LOAD**" terminal are classified as **Essential Load**. These appliances require power even in the event of a grid outage, ensuring uninterrupted operation.

### ► Home Load:

All other electrical appliances in the household that are wired to the grid are considered **Home Load**. These devices are powered through the grid connection under normal operating conditions.

This design ensures critical devices receive prioritized power during power outages, while non-essential devices remain dependent on grid availability.

### ► Recommendation:

1. We suggest connecting loads to **Essential Load** that are critical systems that must remain operational at all times.

**Examples** include medical equipment and storage units, CCTV cameras, internet servers, Wi-Fi routers, refrigerators, desktop computers, etc.

2. We suggest connecting loads to **Home Load** that can tolerate power interruptions. These systems do not require constant electricity and can be powered on or off as needed.

**Examples** include non-critical household appliances: televisions, washing machines, dishwashers, electric kettles, microwave ovens, coffee makers, air conditioners, etc.

## 10.2 Work Mode Overview

### 10.2.1 UPS Mode

The UPS (Uninterruptible Power Supply) mode is a critical feature designed to ensure continuous power supply during grid outages. When enabling UPS mode and the grid fails, it draws power from the solar system or battery storage to maintain electricity for the household. This feature helps prevent downtime and ensures that essential devices continue to operate seamlessly.

UPS mode is particularly valuable in regions with unreliable grid service, providing peace of mind that power will remain available during disruptions. In this mode, the system functions as a backup power source, delivering energy instantly with no noticeable delay.

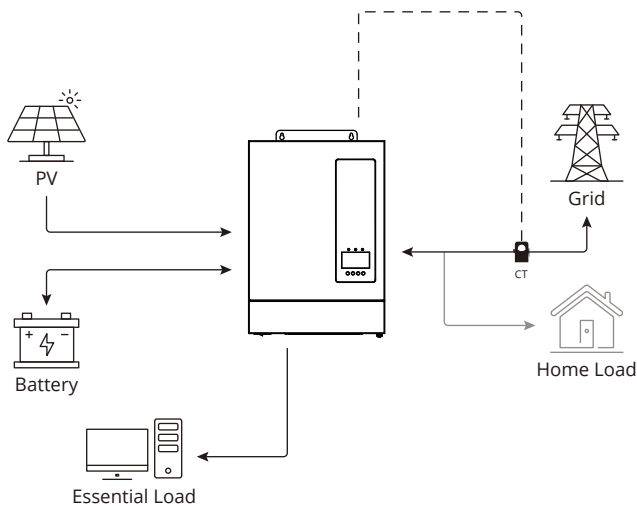

## ► Key Features

**1.Normal Grid State:** The load is powered by solar energy and grid power. The battery is only charged and does not discharge.

**2.Grid Outage:** The system switches to off-grid mode, ensuring uninterrupted power supply to **Essential Load**.

## ► Operational Priorities

### 1.When the Grid is Available:

- **Battery at 100% State of Charge (SOC):** Solar power supplies the load as a priority. If solar power is insufficient, grid power supplements the load.
- **Battery Below 100% SOC:** Grid power supplies the load, while solar power charges the battery. If solar power is not available, the grid charges the battery.
- **Battery Discharge Policy:** The battery will not discharge to power the load when the grid is operational.
- **Solar Power Usage Priority:** Battery > Load > Grid

### 2.When the Grid is Unavailable:

- **Load Supply:** The load is powered by a combination of battery and solar power.
- **Excess Solar Power:** When the PV power exceeds the load power, the surplus energy will be used to charge the battery.

## ► Notice

1.Only the loads connected to the "**LOAD**" terminal, classified as **Essential Load**, will be functional in **UPS mode**.

2.In order to charge the battery using grid power, the "**Charge From AC**" option in "**Battery Settings**" must be enabled.

## 10.2.2 Zero Export Mode

Zero export mode is designed to prevent any surplus solar energy from being exported to the grid. When enabled, this mode prioritizes solar energy for powering loads, with any surplus energy stored in the battery for later use, with none being sent back to the grid.

This feature is particularly beneficial in regions with strict regulations or policies that restrict the export of solar energy. It gives users full control over their energy consumption and storage, ensuring that no energy is wasted and helping to minimize electricity costs. The system continuously monitors energy demand, adjusting the energy flow to maintain zero export levels.

Zero export mode can be programmed to activate automatically during certain hours or conditions, offering a convenient and hands-off approach. Additionally, it enhances grid stability by reducing the strain on local infrastructure caused by unpredictable energy exports.

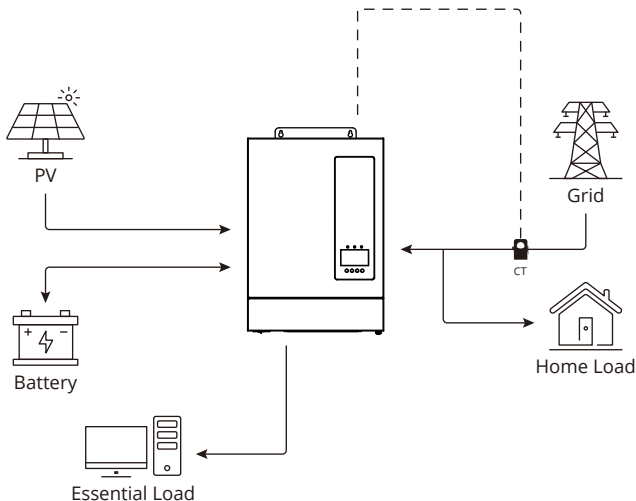

## ► Key Features

- 1.This mode is ideal for maximizing solar energy utilization while complying with regulations that prohibit feed-in to the grid.
- 2.The Current Transformer (CT) is essential to realize the function of **Zero Export**.
- 3.Battery Charging: If PV power exceeds load demands, the excess energy is used to charge the battery.
- 4.Make sure the "**Charge from AC**" under "**Battery Settings**" and "**Mains charge the battery (AC Charges Battery)**" under "**Mains Charge/ Discharge Settings (Work Control Settings)**" are turned on to allow the battery to charge from the grid. If these settings are off, the battery will only be charged from excess photovoltaic (PV) power.

## ► Operational Priorities

### **1.Load Supply Priority: Solar > Battery > Grid**

Solar energy is the primary power source for loads.

If solar power is insufficient, the battery will also supply power to loads, with the grid being the last option to satisfy the demand of load consumption.

### **2.Solar Power Consumption Priority: Load > Battery > Grid**

Solar power is first used to meet load requirements.

Any excess solar power charges the battery.

### **3.The priority order of grid power distribution: Load > Battery**

# 11. Work Mode Settings

## 11.1 Battery Settings Overview

Properly configuring the battery parameters is critical for safe and optimal system performance.

### ► Important Notices:

**1. Consult Your Battery Supplier:** Properly configuring the battery parameters is critical for safe and optimal system performance.

**2. Safety First:** Incorrect battery configurations can lead to damage, safety hazards, or even explosions. Always follow your battery manufacturer's guidelines and consult your battery supplier before adjusting any of the following settings.

### ► Battery Settings Configuration:

**1. Charge From AC:** This setting allows users to enable grid power for battery charging.

**2. Battery Type:** Select one of the following options based on your battery setup.

- **Battery Pack:** For batteries with a **BMS**.

Under **SOC/Voltage**, select either **SOC** or **Voltage** to configure the battery settings.

Choose the matching **Battery Protocol** for your battery.

- **User:**

For batteries **without** a Battery Management System (**BMS**). Manually enter all relevant specifications after consulting with the battery supplier.

- **No Battery:**

If no battery is installed and the inverter is used solely as a grid-tie inverter, select this option.

**Notice:** The "**Boost Charge Voltage**" and "**Float Charge Voltage**" are automatically configured by the battery with Management System (**BMS**). If your battery does not include a **BMS**, you must manually set these voltages under the "**User**" option in the "**Battery Type**" settings.

**3. Battery Capacity:** This setting allows users to select the battery's total capacity.

**4. Low Voltage Protection (Low Capacity cutoff point):** This setting determines the voltage level at which the battery will stop discharging.

**5. Battery Recovery Voltage (Protecting recovery point):** This setting represents the level of voltage that the battery needs to be charged up to after the low-voltage protection kicks in.

**6. Maximum Charge Current:** This setting allows users to set the maximum charge current.

**7. Maximum Discharge Current:** This setting allows users to set the maximum discharge current.

**8. Boost Charge Voltage:** This setting allows users to set the voltage reached during bulk (constant-current) charging.

**9. Float Charge Voltage:** A low, constant voltage is applied after the battery is fully charged to counter self-discharge. This is often unnecessary for LiFePO<sub>4</sub> batteries but commonly used for lead-acid batteries.

**10. Equalizing Charge Voltage:** Equalizing charge is primarily used for lead-acid batteries to balance the cells. It is typically required for lead-acid batteries, but not for LiFePO<sub>4</sub> batteries.

**11. Equalizing Charge Time:** If imbalance occurs (e.g., reduced performance or capacity), set the duration (1–90 minutes) for the equalizing charge. This is not required for LiFePO<sub>4</sub> batteries.

**12. Equalizing Charge Interval:** For lead-acid batteries, users should select the frequency (1–90 days) for an equalizing charge, depending on usage and battery condition. This is typically used for lead-acid batteries and is not required for LiFePO<sub>4</sub> batteries.

**For all the settings mentioned above, please refer to the LightEarth Mobile App for further configuration and adjustments.**

**ATTENTION:** Please note that the chart below uses theoretical data to illustrate how battery SOC and voltage may correlate. Actual performance varies by manufacturers and battery chemistry - particularly for LiFePO4 batteries - so the chart should be viewed as **reference only**.

The following hypothetical examples are based on the chart's data and assume sufficient solar irradiance. Real-World conditions will may vary.

SOC	Volt per Cell	48V (15 Cell)	51.2V (16 Cell)	57.6V (18 Cell)
100.00%	3.65	54.75	58.4	65.7
99.50%	3.45	51.75	55.2	62.1
99.00%	3.38	50.7	54.08	60.84
90.00%	3.35	50.25	53.6	60.3
80.00%	3.33	49.95	53.28	59.94
70.00%	3.3	49.5	52.8	59.4
60.00%	3.28	49.2	52.48	59.04
50.00%	3.26	48.9	52.16	58.68
40.00%	3.25	48.75	52	58.5
30%	3.23	48.45	51.68	58.14
20%	3.2	48	51.2	57.6
15%	3.05	45.75	48.8	54.9
9.5%	3	45	48	54
5%	2.8	42	44.8	50.4
0.5%	2.54	38.1	40.64	45.72
0%	2.5	37.5	40	45

The following hypothetical examples and operating guides are based on hypothetical assumptions. Actual performance will vary depending on local weather conditions, system efficiency and real energy consumption patterns.

## 11.2 UPS Mode



Brian lives in a country with an unstable electricity grid, resulting in frequent power outages. He seeks a reliable and continuous source of electricity to mitigate the impacts of these outages.

**Brian's Solar Equipment and Battery Specifications**

Category	Specs Description	Details
Solar Panels	Number of Panels	10x580W
	Type	LiFePO4 Battery
Battery	Battery Nominal Voltage	48V
	Battery Capacity	300Ah
	Battery Rated Discharge Current	130A
	Battery Rated Charge Current	120A

**Brian's Household Energy Usage**

Category	Appliance	Power (W/h)	Operating Hours	Daily Consumption (Wh)
Essential Load	1 Refrigerator	50	24	1200
	1 Medical Storage Equipment	100	24	2400
Home Load	5 Light Bulbs	10	5 (18:00-23:00)	250
	1 Television	100	3	300
	1 Induction Cooker	1500	1 (18:00-19:00)	1500
Total Daily Load				5650

### ► Solar Power Generation and Battery Charging:

With the solar panels Brian has, assuming an effective charging power of **80%** of the rated output due to real-world conditions, and inverter efficiency of **97.6%**.

**Total Solar Power:  $580W \times 10 \times 80\% \times 97.6\% \approx 4529W \approx 4.53kW$ .**

**Total Battery Energy:  $300Ah \times 48V = 14,400Wh = 14.4kWh$ .**

**Charging Time = Battery Energy (kWh) / Solar Power (kW)**  
 **$= 14.4kWh \div 4.53kW \approx 3.2$  hours.**

This means that with adequate sunlight, the solar system can fully recharge the battery in just over **3** hours with no load consumption.

### Self-Sufficiency and Backup Power

Given that Brian's battery has a total energy capacity of **14.4kWh**, which is more than sufficient to meet his daily consumption of **5650Wh (5.65kWh)**, he can depend entirely on the battery for his household's energy needs during the day if solar energy generation is sufficient.

In the event of extended grid outages (lasting up to two days with overcast skies and minimal solar energy generation), Brian will remain fully self-sufficient with his current setup, as long as his solar panels generate enough power during the day to recharge the battery.

To ensure a consistent supply of electricity in the household while reducing costs associated with electricity consumption, the following settings and strategies should be implemented.

## Operating Guide:

The operation guide is based on the Light Earth app. Please follow the instructions to complete settings.

**Notice: Red-highlighted terms in the same step have the same meaning. Future app versions will standardize them into a single term.**

1. Go to Work Mode Settings → Select **"No limit Function Mode (UPS mode)"**
2. Go to battery Settings:
  - Battery type: Choose **"User"**
  - Turn on the toggle for **"Charge From AC"**
  - Battery Capacity: Enter **"300 Ah"**
  - Maximum Charge Current: **120A**
  - Maximum discharge Current: **130A**
  - **Low Capacity cutoff point (Low Voltage Protection): 48V**
  - **Protecting recovery point (Battery Recovery Voltage): 48.5V**
  - Boost Charge Voltage: **54.5V**
  - Float Charge Voltage: **54.5V**

## 11.3 Zero Export Mode

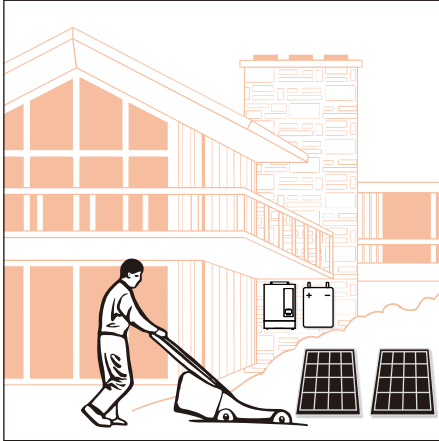

Phil lives in an area with exceptionally high electricity costs. Hypothetically, the electricity price is highest between 13:00–19:00 and lowest from 01:00–07:00. To minimize costs, he aims to maximize solar energy usage and avoid exporting excess power to the grid during expensive peak hours.

**Phil's Solar Equipment and Battery Specifications**

Category	Specs Description	Details
Solar Panels	Number of Panels	12×550W
	Type	LiFePO4 Battery
Battery	Battery Nominal Voltage	48V
	Battery Capacity	200Ah
	Battery Rated Discharge Current	100A
	Battery Rated Charge Current	100A

**Phil's Household Energy Usage**

Category	Appliance	Power (W/h)	Operating Hours	Daily Consumption (Wh)
Essential Load	1 Refrigerator	50	24	1200
	1 Internet Server	100	24	2400
Home Load	8 Light Bulbs	10	5 (18:00–23:00)	400
	1 Computer	100	10 (07:00–12:00 13:00–18:00)	1000
	1 Air Conditioner	1000	5 (18:00–23:00)	5000
Total Daily Load				10000

### ► Zero Export Mode Configuration:

- **Solar Energy Priority:** Configure the system to use solar energy as the primary source of power during the day.
- **Battery Charging:** Charge the battery using grid power during off-peak hours (01:00-07:00).
- **Battery Usage:** Use stored battery energy to power the home loads during peak hours (13:00-19:00).
- **Goal:** Minimize reliance on expensive grid electricity and avoid unnecessary energy export costs.

### Operating Guide:

The operation guide is based on the Light Earth app. Please follow the instructions to complete settings.

**Notice:** Red-highlighted terms in the same step have the same meaning. Future app versions will standardize them into a single term.

1. Go to Work Mode Settings → Select **"Limit function Mode (Economic mode)" - Zero Export Mode**
2. Go to battery Settings:
  - Battery type: Choose **"User"**
  - Turn on the toggle for **"Charge From AC"**
  - Battery Capacity: Enter **"200 Ah"**
  - Maximum Charge Current: **100A**
  - Maximum discharge Current: **100A**
  - **Low Capacity cutoff point (Low Voltage Protection): 48V**
  - **Protecting recovery point (Battery Recovery Voltage): 50V**
  - Boost Charge Voltage: **54.5V**
  - Float Charge Voltage: **54.5V**
3. Go to **Mains Charge/Discharge Settings (Work Control Settings):**
  - Go to **The battery discharge to the loads (Battery Discharge)**.
  - Turn on the toggle on the right of the "First discharge time".
  - Select time: **13:00 to 23:59**
  - Target Voltage Setting: **48V**
  - Discharge Power: **3000W** ; Maximum discharge current: **100A**

# 12. Troubleshooting

Error Code	Description	Solutions
E10	Power module fault	<ol style="list-style-type: none"> <li>1. Check whether the power supply is normal.</li> <li>2. Replace the power-supply board.</li> </ol>
E13	Operating mode switched	<ol style="list-style-type: none"> <li>1. Reboot the inverter.</li> <li>2. Verify the operating mode in Settings.</li> </ol>
E14	DC current overload	<ol style="list-style-type: none"> <li>1. Reduce the load.</li> <li>2. Replace the control board.</li> <li>3. If the fault reappears, remove the main-board and test the IGBTs for short circuits.</li> </ol>
E15	Short-circuit protection	<ol style="list-style-type: none"> <li>1. Reboot the inverter.</li> <li>2. Replace the control board.</li> <li>3. Check whether the main-board IGBTs are shorted.</li> <li>4. Test whether the AC current transformer (CT) and its supply voltage are normal.</li> </ol>
E16	AC hardware overcurrent	<ol style="list-style-type: none"> <li>1. Replace the control board.</li> <li>2. Check the main-board IGBTs for faults.</li> <li>3. Test whether the AC CT is normal.</li> </ol>
E19	Hardware integration fault	<ol style="list-style-type: none"> <li>1. Reboot the inverter.</li> <li>2. Replace the control board.</li> </ol>
E21	PV or DC-DC hardware overcurrent	<ol style="list-style-type: none"> <li>1. Replace the control board.</li> <li>2. Inspect the main-board: check H6-bridge IGBTs and MOSFETs for shorts.</li> </ol>
E25	Low DC bus voltage during battery activation	<ol style="list-style-type: none"> <li>1. Verify the battery is operating normally; measure battery voltage.</li> <li>2. Check that the battery cables are properly connected.</li> </ol>
E29	CAN bus communication failure	<ol style="list-style-type: none"> <li>1. Ensure the communication cable is fully seated and connected to the correct port.</li> <li>2. Verify master/slave configuration between units.</li> <li>3. Replace the communication cable.</li> </ol>
E31	DC bus undervoltage in battery-less mode	<ol style="list-style-type: none"> <li>1. Check that AC input is present and its voltage is within the inverter's operating range.</li> <li>2. Confirm PV voltage is within range.</li> <li>3. If unresolved, replace the control board.</li> </ol>
E35	Overload protection	<ol style="list-style-type: none"> <li>1. Check whether output power is overloaded.</li> <li>2. Reduce load.</li> <li>3. If the fault occurs with no load, replace the control board.</li> </ol>
E37	DC-DC overcurrent (battery activation)	<ol style="list-style-type: none"> <li>1. Check if the battery entered protection; restart the battery.</li> <li>2. Reduce load.</li> <li>3. Replace the control board.</li> <li>4. If still unresolved, remove and test the main-board IGBTs and current transformers (CTs).</li> </ol>
E39	DC-DC overcurrent (software LLC)	<ol style="list-style-type: none"> <li>1. Check if the battery entered protection; restart the battery.</li> <li>2. Reduce load.</li> <li>3. Replace the control board.</li> <li>4. If still unresolved, remove and test the main-board IGBTs and current transformers (CTs).</li> </ol>

Error Code	Description	Solutions
E40	DC-DC current too high	<ol style="list-style-type: none"> <li>1. Check if the battery entered protection; restart the battery.</li> <li>2. Reduce load.</li> <li>3. Replace the control board.</li> <li>4. If still unresolved, remove and test the main-board IGBTs and current transformers (CTs).</li> </ol>
E41	Parallel-operation fault	<ol style="list-style-type: none"> <li>1. In a parallel system, ensure none of the inverters are off.</li> <li>2. Confirm all units are powered on.</li> <li>3. Check the parallel communication cabling.</li> </ol>
E45	AC voltage fault	<ol style="list-style-type: none"> <li>1. Reboot the inverter.</li> <li>2. Verify grid voltage is within the operating range.</li> </ol>
E46	AC voltage fault (grid undervoltage)	<ol style="list-style-type: none"> <li>1. Reboot the inverter.</li> <li>2. Verify grid voltage is within the operating range.</li> </ol>
E47	Grid frequency too high	<ol style="list-style-type: none"> <li>1. Reboot the inverter.</li> <li>2. Verify grid frequency is within the operating range.</li> </ol>
E48	Grid frequency too low	<ol style="list-style-type: none"> <li>1. Reboot the inverter.</li> <li>2. Verify grid frequency is within the operating range.</li> </ol>
E55	Parallel-operation fault	<ol style="list-style-type: none"> <li>1. In a parallel system, ensure none of the inverters are off.</li> <li>2. Confirm all units are powered on.</li> <li>3. Check the communication cabling.</li> </ol>
E60	Over-temperature protection	<ol style="list-style-type: none"> <li>1. Compare displayed temperature with actual.</li> <li>2. Check whether the fans are running.</li> <li>3. Ensure the air vents are unobstructed.</li> <li>4. Clean dust buildup at the vents.</li> </ol>
E61	Over voltage protection	<ol style="list-style-type: none"> <li>1. Check that battery voltage is within the operating range.</li> <li>2. If measured (telemetry) voltage is much higher than actual, replace the control board.</li> <li>3. If the issue persists, check the main-board battery voltage sampling circuit (component U44).</li> </ol>
E62	Under voltage protection	<ol style="list-style-type: none"> <li>1. Check that battery voltage is within the rated range.</li> <li>2. If measured (telemetry) voltage is much higher than actual, replace the control board.</li> <li>3. If still unresolved, check the main-board battery voltage sampling circuit (component U44).</li> <li>4. Verify the battery provides power.</li> <li>5. Check battery connections and that reported voltage matches actual.</li> </ol>

# 13. Technical Parameters

Technical Parameter		SUNT-6.0kW-HP
<b>Battery Input (DC Input)</b>		
Supported Battery Type	LiFePO4 or Lead-Acid	
Battery Input Voltage Range (V)	40~60	
Max. Charge Voltage (V)	60 (Configurable)	
Max. Charge Current (A)	120 (Configurable)	
Max. Discharge Current (A)	130 (Configurable)	
Battery Capacity (Ah) (Recommend)	100~2000	
Charge for LiFePO4 Battery Pack	Communicating with BMS of the Battery Pack	
<b>PV String Input (DC Input)</b>		
Max. DC Input Power (W)	8000	
Max. DC Input Voltage (V)	500	
MPPT Voltage Range (V)	120~450	
Start-Up Voltage (V)	150	
Max. Input Current (A)	15x2 =30 2 MPPT Channels	
<b>AC Output (Back-Up) Feed to Essential Load</b>		
Max. Output Power (W)	6000	
Max. Output Apparent Power (VA)	6000	
Peak Output Apparent Power (VA)	12000	
Max. Output Current (A)	27	
Nominal Output Voltage (Vac)	220/230/240 (Configurable) Single Phase	
Nominal Output Frequency (Hz)	50/60 (+/-0.2%) (Configurable)	
Max. Bypass Current (A)	40	
Shift Time (Bypass and Inverter) (ms)	10	
Output THD (Resistor Load)	<3%	
<b>AC Input (On-Grid) Bypass to Essential Load/Charge the Battery/Feed to Home Load</b>		
Max. Input Power (W)	6000	
Bypass to Essential Load/Charge the Battery	6000	
Max. Output Power (W)	6000	
Feed to Home Load	6000	
Max. Apparent Input Power (VA)	6000	
Bypass to Essential Load/Charge the Battery	6000	
Max. Apparent Output Power (VA)	6000	
Feed to Home Load	6000	
Nominal Input/Output Voltage (V)	220/230/240 (Auto Adjusted to Fit Home Grid) Single Phase	
Nominal Input/Output Frequency (Hz)	50/60 (Auto Adjusted to Fit Home Grid)	
Max. Bypass Current (A)	40	
Shift Time (Bypass and Inverter) (ms)	10	
<b>Efficiency</b>		
Max. Efficiency	97.60%	
Max. Battery to Load Efficiency	94.0%	
Europe Efficiency	97.60%	
MPPT Efficiency	99.9%	
<b>Protection</b>		
Integrated	Battery Over Charge Protection, Battery Low Voltage Protection, Over Temperature Protection , Output Overload Protection, Output Short Circuit Protection, Output Over Voltage Protection	
<b>Certifications &amp; Standards</b>		
Grid Regulation & Safety/EMC Regulation	VDE-AR-N 4105; UNE 217001; G100; EN 50549-1; IEC 61727; IEC 62116; IEC 61683; IEC/EN 61000-6-1/3; IEC/EN 62109-1/2	
<b>General Data</b>		
Operating Temperature Range	-25°C~60°C (>35°C Derating)	
Protection Degree	IP41	
Size (LxWxH) (mm)	353x135x536	
Net Weight (kg)	13.7	



**Web:** <http://www.lumentree.co>    **Email:** [mcrey@lumentree.co](mailto:mcrey@lumentree.co)  
**Add:** 508B-2, Building 2, No.7 Beisha East Road, Donghu Street  
Linping District, Hangzhou, Zhejiang, China



Website



LightEarth

